

**BARIS**

**Standard Features:**

- Premium high-density, high-resiliency foam seat
- Loose back and tight seat cushions
- Unique seat cushion design doubles as a mattress section
- Zero wall clearance
- Single-needle top-stitch
- Lifetime warranty on frame
- Limited three-year warranty on mechanism
- Quick-ship delivery

**Options:**

- Wood legs in Acorn, Espresso or Walnut finish

**Mattress:**

- Four inches of high-density, high-resiliency foam

**Leg height is 4"**

Please use actual leather, fabric, Crypton®, Sunbrella® and Ultrasuede® swatches when specifying furniture as the colors shown may vary due to the printing process.

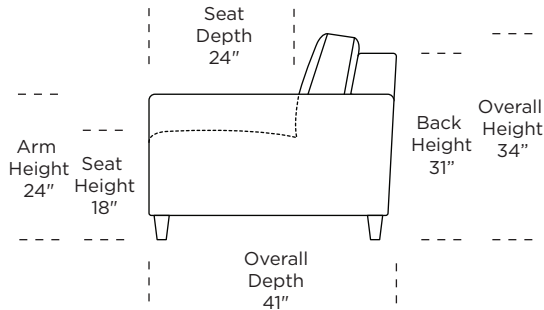
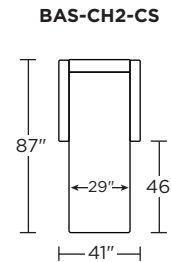
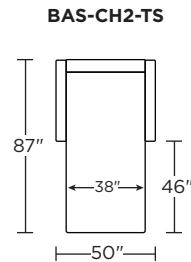
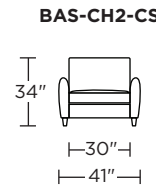
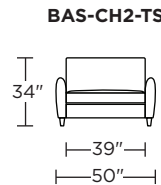
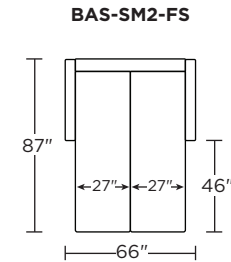
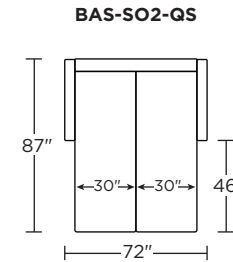
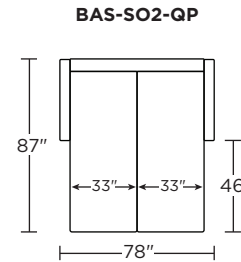
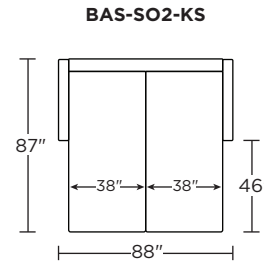
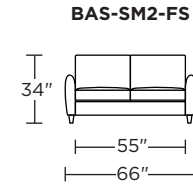
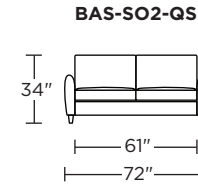
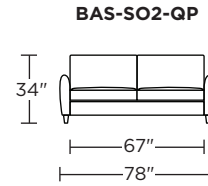
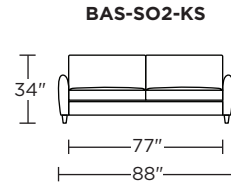

Scale: 1/8 inch = 1 foot  
All dimensions are approximate and subject to change.  
Specify components from the sitting position.